



<i>Introduction</i>	<i>TS 03</i>
<i>Grade Description</i>	<i>TS 04</i>
<i>Usage Reference Guide</i>	<i>TS 06</i>
<i>Pictorial Index</i>	<i>TS 07</i>
<i>Inserts</i>	<i>TS 08-10</i>
<i>Toolholders</i>	<i>TS 11-12</i>



Greenleaf Sales

Phone: 814-763-2915 • 800-458-1850 • Fax: 814-763-4423
sales@greenleafcorporation.com • www.greenleafcorporation.com

Tube Scarfing

Greenleaf's modern tube scarfing system using indexable inserts offers greatly increased productivity potential from decreased downtime, longer tool life, faster tool change time, decreased tool costs and elimination of regrinding problems. In addition, a superior seam can be expected since an accurate radius form is always available on each side of the insert.



CARBIDE

Greenleaf offers a comprehensive line of carbide inserts in grades ranging from sub-micron C-1 through C-8 classifications. An industry pioneer in coated carbide, Greenleaf offers a variety of uncoated, CVD-coated and PVD-coated grades. Carbide inserts are available in ANSI standard geometries with multi-purpose chip-breakers for heavy roughing through finishing.

COATED

GA-5025 A CVD ceramic-coated grade offering superior heat resistance and long tool life.

CERAMIC

Greenleaf is the industry leader in the development and manufacture of ceramic and coated ceramic inserts in ANSI standard and special geometries. Some of the most prominent include:

GEM-19 An Al₂O₃ ceramic grade for high-speed operations and demanding finish requirements.

Greenleaf Sales

Phone: 814-763-2915 • 800-458-1850 • Fax: 814-763-4423
sales@greenleafcorporation.com • www.greenleafcorporation.com



S-SPUB-63

Shape Scarfing	Order Number	Tube Size	Radius
	S-SPUB-63-B	10 to 8.75"	0.475
	S-SPUB-63-C	8.75 to 1.125"	0.590
	S-SPUB-63-D	1.125 to 1.5"	0.705
	S-SPUB-63-E	1.500 to 2.000"	0.820
	S-SPUB-63-F	2.000 to 2.250"	0.935
	S-SPUB-63-G	2.250 to 3.125"	1.050
	S-SPUB-63-H	3.125 to 3.875"	1.165
	S-SPUB-63-I	3.875 to 4.625"	1.280
	S-SPUB-63-J	4.625 to 5.375"	1.395
	S-SPUB-63-K	5.375 to 6.125"	1.510
	S-SPUB-63-L	6.125 to 8.000"	1.625
	* S-SPUB-63-M	7.875 and up	NONE
	S-SPUB-63-N		0.900
	S-SPUB-63-O		0.775

DVD Coated Ceramic
*Note: this insert has 11" positive clearance all around

S-SGUE-63

Additional flank clearance for coated tube operations.

Shape Scarfing	Order Number	Tube Size	Radius
	S-SGUE-63-B	10 to 8.75"	0.475
	S-SGUE-63-C	8.75 to 1.125"	0.590
	S-SGUE-63-D	1.125 to 1.500"	0.705
	S-SGUE-63-E	1.500 to 1.875"	0.820
	S-SGUE-63-F	1.875 to 2.250"	0.935
	S-SGUE-63-G	2.250 to 3.125"	1.050
	S-SGUE-63-H	3.125 to 3.875"	1.165
	S-SGUE-63-I	3.875 to 4.625"	1.280
	S-SGUE-63-J	4.625 to 5.375"	1.395
	S-SGUE-63-K	5.375 to 6.125"	1.510
	S-SGUE-63-L	6.125 to 7.875"	1.625
	* S-SGUE-63-M	7.875 and up	NONE
	S-SGUE-63-N		0.875
	S-SGUE-63-O		0.750
	S-SGUE-63-P		0.600

DVD Coated Ceramic
*Note: this insert has 30" positive clearance all around

S-SPUB-86

Additional thickness and flank clearance for heavy-wall pipe and pipe diameters over 5" available.

Shape Scarfing	Order Number	Tube Size	Radius
	S-SPUB-86-B	10 to 8.75"	0.475
	S-SPUB-86-C	8.75 to 1.125"	0.590
	S-SPUB-86-D	1.125 to 1.500"	0.705
	S-SPUB-86-E	1.500 to 1.875"	0.820
	S-SPUB-86-F	1.875 to 2.250"	0.935
	S-SPUB-86-G	2.250 to 3.125"	1.050
	S-SPUB-86-H	3.125 to 3.875"	1.165
	S-SPUB-86-I	3.875 to 4.625"	1.280
	S-SPUB-86-J	4.625 to 5.375"	1.395
	S-SPUB-86-K	5.375 to 6.125"	1.510
	S-SPUB-86-L	6.125 to 7.875"	1.625
	* S-SPUB-86-M	7.875 and up	NONE
	S-SPUB-86-N		0.900
	S-SPUB-86-O		0.775
	S-SPUB-86-P		0.250

DVD Coated Ceramic
*Note: this insert has 12" positive clearance all around

S-SNUN-46

Ceramic-Style Insert

Shape Scarfing	Order Number	Tube Size	Radius
	S-SNUN-46-B	10 to 8.75"	0.475
	S-SNUN-46-C	8.75 to 1.125"	0.590
	S-SNUN-46-D	1.125 to 1.500"	0.705
	S-SNUN-46-E	1.500 to 1.875"	0.820
	S-SNUN-46-F	1.875 to 2.250"	0.935
	S-SNUN-46-G	2.250 to 3.125"	1.050
	S-SNUN-46-H	3.125 to 3.875"	1.165

DVD Coated Ceramic
*Note: this insert has 30" positive clearance all around

Greenleaf Sales
Phone: 814-763-2915 • 800-458-1850 • Fax: 814-763-4423
sales@greenleafcorporation.com • www.greenleafcorporation.com

Stocked Standard Stocked or Available Upon Request

Greenleaf Sales
Phone: 814-763-2915 • 800-458-1850 • Fax: 814-763-4423
sales@greenleafcorporation.com • www.greenleafcorporation.com

Stocked or Available Upon Request Stocked Standard

Inserts



SBUP-63
page: TS 08



SBUP-86
page: TS 08



SGUB-63
page: TS 09



S-SNUN-46
page: TS 09

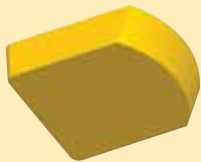

84-620-43
page: TS 10

Toolholders

N-CSCPS
page: TS 11

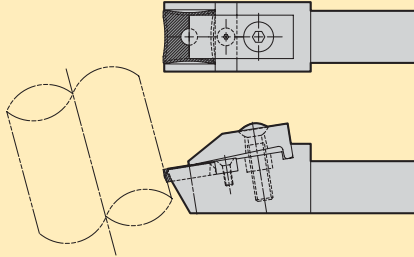

N-SSCPS
page: TS 11

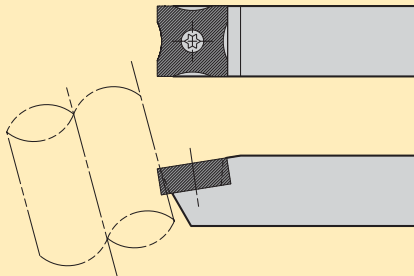

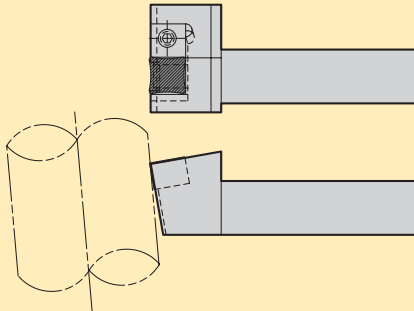

N-WSCNN
page: TS 12





S-SPUB-63

Shape: Scarfing	Order Number	GA-5025	Dimensions (inches)	
			Tube Size	Radius
	S-SPUB-63-B	●	Up to .875"	0.475
	S-SPUB-63-C	●	.875-1.125"	0.590
	S-SPUB-63-D	●	1.125-1.5"	0.785
	S-SPUB-63-R	○	1.750"	0.875
	S-SPUB-63-E	●	1.500-1.875"	0.985
	S-SPUB-63-F	●	1.875-2.250"	1.180
	S-SPUB-63-G	●	2.250-3.125"	1.575
	S-SPUB-63-H	●	3.125-3.875"	1.970
	S-SPUB-63-I	●	3.875-4.875"	2.470
	S-SPUB-63-J	●	4.875-5.875"	2.970
	S-SPUB-63-K	●	5.875-6.875"	3.470
	S-SPUB-63-L	●	6.875-7.875"	3.970
	* S-SPUB-63-M	●	7.875 and Up	NONE
	S-SPUB-63-P	○		6.000
	S-SPUB-63-S	●		0.375

 CVD Coated Ceramic

*Note: this insert has 11° positive clearance all around

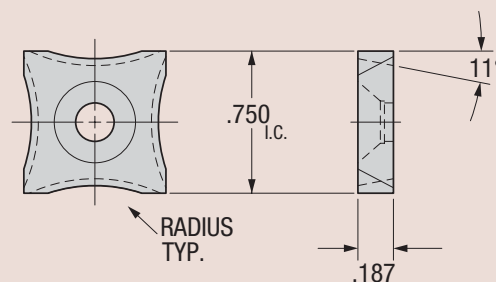

S-SPUB-86

Additional thickness and flank clearance for heavy-wall pipe and pipe diameters over 5" available.

Shape: Scarfing	Order Number	GA-5025	Dimensions (inches)	
			Tube Size	Radius
	S-SPUB-86-B	○	Up to .875"	0.475
	S-SPUB-86-C	○	.875-1.125"	0.590
	S-SPUB-86-D	○	1.125-1.500"	0.785
	S-SPUB-86-E	○	1.500-1.875"	0.985
	S-SPUB-86-F	●	1.875-2.250"	1.180
	S-SPUB-86-G	●	2.250-3.125"	1.575
	S-SPUB-86-H	●	3.125-3.875"	1.970
	S-SPUB-86-I	●	3.875-4.875"	2.470
	S-SPUB-86-J	●	4.875-5.875"	2.970
	S-SPUB-86-K	○	5.875-6.875"	3.470
	S-SPUB-86-L	○	6.875-7.875"	3.970
	* S-SPUB-86-M	●	7.875" and up	NONE
	S-SPUB-86-N	○		5.000
	S-SPUB-86-S	○		9.500
	S-SPUB-86-P	○		6.250

 CVD Coated Ceramic

*Note: this insert has 13° positive clearance all around

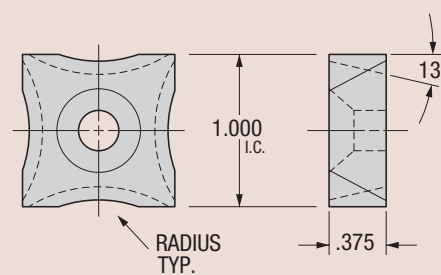

Greenleaf Sales

Phone: 814-763-2915 • 800-458-1850 • Fax: 814-763-4423
 sales@greenleafcorporation.com • www.greenleafcorporation.com

 Stocked Standard

 Stocked or Available Upon Request



S-SGUB-63

Additional flank clearance for coated tube operations.

Shape: Scarfing	Order Number	GA-5025	Tube Size	Dimensions (inches)	
				Radius	
	S-SGUB-63-B	○	Up to .875"	0.475	
	S-SGUB-63-C	○	0.875-1.125"	0.590	
	S-SGUB-63-D	○	1.125-1.500"	0.785	
	S-SGUB-63-E	○	1.500-1.875"	0.985	
	S-SGUB-63-F	○	1.875-2.250"	1.180	
	S-SGUB-63-G	○	2.250-3.125"	1.575	
	S-SGUB-63-H	○	3.125-3.875"	1.970	
	S-SGUB-63-I	○	3.875-4.875"	2.470	
	S-SGUB-63-J	○	4.875-5.875"	2.970	
	S-SGUB-63-K	○	5.875-6.875"	3.470	
	S-SGUB-63-L	○	6.875-7.875"	3.970	
	* S-SGUB-63-M	○	7.875 and Up	NONE	
	S-SGUB-63-R	○	1.750" DIA	0.875	
	S-SGUB-63-S	○		0.375	
S-SGUB-63-P	○		6.000		

 CVD Coated Ceramic

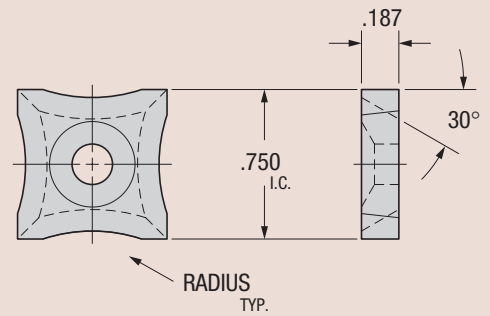

*Note: this insert has 30° positive clearance all around

S-SNUN-46

Ceramic-Style Insert

Shape: Scarfing	Order Number	GEM-19	Tube Size	Radius Size	Dimensions (inches)	
					Radius	
	S-SNUN-46-B	○	up to .875"	0.475"	0.500	
	S-SNUN-46-C	○	.875-1.125"	0.590"	0.500	
	S-SNUN-46-D	●	1.125-1.500"	0.785"	0.500	
	S-SNUN-46-E	●	1.500-1.875"	0.985"	0.500	
	S-SNUN-46-F	●	1.875-2.250"	1.180"	0.500	
	S-SNUN-46-G	●	2.250-3.125"	1.575"	0.500	
	S-SNUN-46-H	○	3.125-3.875"	1.970"	0.500	

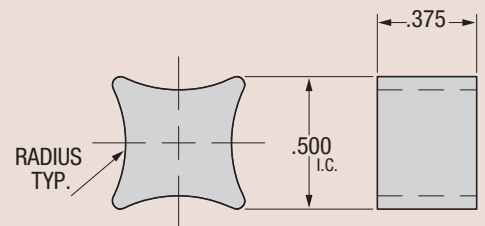

Stocked or Available Upon Request 

Stocked Standard 

Greenleaf Sales
 Phone: 814-763-2915 • 800-458-1850 • Fax: 814-763-4423
 sales@greenleafcorporation.com • www.greenleafcorporation.com



ID Scarfing Insert 84_620_43_Model

Other sizes available upon request.

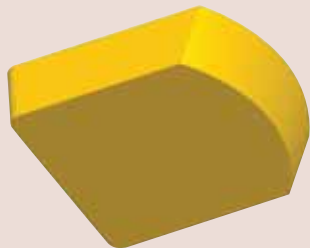
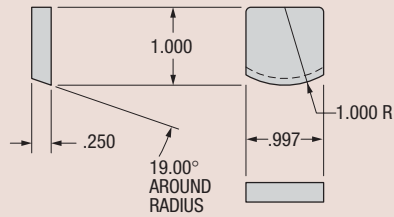

Greenleaf Sales

Phone: 814-763-2915 • 800-458-1850 • Fax: 814-763-4423
sales@greenleafcorporation.com • www.greenleafcorporation.com

Stocked Standard

Stocked or Available Upon Request



N-CSCPS

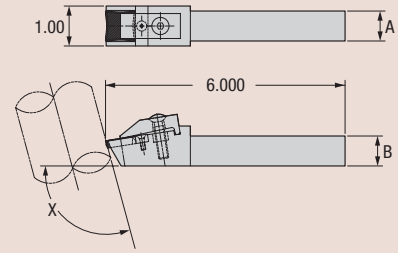

Order Number	Gage Insert	Stock	Angle X	Dimensions (inches)		Standard Components					Tune-Up Kit Includes All Standard Components
				A	B	Clamp	Clamp Screw	Back-Up Plate	Plate Screw	Retaining Spring	
N-CSCPS-12-6-90	S-SPUB-63	○	90°	0.75	0.75	428170	NCS-1-10	313005	#4-40 x 3/8 FHCS	NRS-1-10	TK-00873
N-CSCPS-12-6-95	S-SPUB-63	○	95°	0.75	0.75	428170	NCS-1-10	313005	#4-40 x 3/8 FHCS	NRS-1-10	TK-00873
N-CSCPS-12-6-100	S-SPUB-63	○	100°	0.75	0.75	428170	NCS-1-10	313005	#4-40 x 3/8 FHCS	NRS-1-10	TK-00873
N-CSCPS-12-6-105	S-SPUB-63	○	105°	0.75	0.75	428170	NCS-1-10	313005	#4-40 x 3/8 FHCS	NRS-1-10	TK-00873
N-CSCPS-16-6-90	S-SPUB-63	○	90°	1.00	1.00	428170	NCS-1-10	313005	#4-40 x 3/8 FHCS	NRS-1-10	TK-00873
N-CSCPS-16-6-95	S-SPUB-63	○	95°	1.00	1.00	428170	NCS-1-10	313005	#4-40 x 3/8 FHCS	NRS-1-10	TK-00873
N-CSCPS-16-6-100	S-SPUB-63	○	100°	1.00	1.00	428170	NCS-1-10	313005	#4-40 x 3/8 FHCS	NRS-1-10	TK-00873
N-CSCPS-16-6-105	S-SPUB-63	○	105°	1.00	1.00	428170	NCS-1-10	313005	#4-40 x 3/8 FHCS	NRS-1-10	TK-00873

N-SSCPS

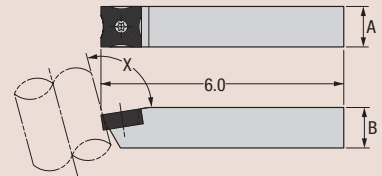

Order Number	Gage Insert	Stock	Angle X	Dimensions (inches)		Tune-Up Kit Includes All Standard Components	Standard Components Insert Screw
				A	B		
N-SSCPS-12-90	S-SPUB-63	●	90°	0.75	0.75	TK-00576	TORX SCREW #10-32 x 1/2
N-SSCPS-12-95	S-SPUB-63	○	95°	0.75	0.75	TK-00576	TORX SCREW #10-32 x 1/2
N-SSCPS-12-100	S-SPUB-63	●	100°	0.75	0.75	TK-00576	TORX SCREW #10-32 x 1/2
N-SSCPS-12-105	S-SPUB-63	●	105°	0.75	0.75	TK-00576	TORX SCREW #10-32 x 1/2
N-SSCPS-16-8-90	S-SPUB-86	○	90°	1.00	1.00	TK-00760	TORX SCREW 1/4-20 x 3/4
N-SSCPS-16-8-95	S-SPUB-86	○	95°	1.00	1.00	TK-00760	TORX SCREW 1/4-20 x 3/4
N-SSCPS-16-8-100	S-SPUB-86	○	100°	1.00	1.00	TK-00760	TORX SCREW 1/4-20 x 3/4
N-SSCPS-16-8-105	S-SPUB-86	●	105°	1.00	1.00	TK-00760	TORX SCREW 1/4-20 x 3/4

Stocked
or Available
Upon Request

Stocked Standard

Greenleaf Sales
 Phone: 814-763-2915 • 800-458-1850 • Fax: 814-763-4423
 sales@greenleafcorporation.com • www.greenleafcorporation.com



N-WSCNN

Ceramic Insert Holder

Order Number	Gage		Angle X	Standard Components		Tune-Up Kit Includes All Std. Components
	Insert	Stock		Wedge	Wedge Screw	
N-WSCNN-12-90	S-SNUN-46	○	90°	303996	38309	TK-00577
N-WSCNN-12-95	S-SNUN-46	○	95°	303996	38309	TK-00577
N-WSCNN-12-100	S-SNUN-46	○	100°	303996	38309	TK-00577
N-WSCNN-12-105	S-SNUN-46	○	105°	303996	38309	TK-00577

